

# USER MANUAL



Thank you for choosing Better Bathrooms.  
Please read this manual before installing your product  
and keep for future reference.

**better**   
**bathrooms**

## SAVMB1695 Ladder Towel Rail

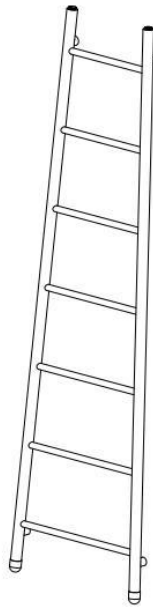

Please note: Image is for illustrative purposes only and may differ slightly to the actual product

- **Multi-person assembly**
- **Tools required**
- **We always recommend using professional tradespeople to install your product**

V1\_25.9.23

# Congratulations on your purchase

*And welcome to our growing gang of savvy shoppers*

We're on a mission to bring you extraordinary bathroom products, for less. From modern to traditional style ceramics, plus the gorgeous fixtures, fittings and furniture to match. So, you can fall in love with your space every single day.

As one of the UK's largest independent bathroom stores, we've received countless awards; including the National Business Awards UK, the Digital Entrepreneur Awards and being placed on The Sunday Times Fast Track 100.

We hope your new product goes above and beyond your expectations. However, should any problems occur, please:

log in to your account and contact our customer services team via your self-serve portal – [betterbathrooms.com/CustomerAccount/Login](https://betterbathrooms.com/CustomerAccount/Login)

contact us via [betterbathrooms.com/content/contact-us](https://betterbathrooms.com/content/contact-us)

## Important information

- Please read these instructions thoroughly and retain for future reference
- Manufactured to BS EN 442-1 Radiators and convectors
- Please ensure that the product is checked for damage prior to installation, any damage reported after installation will not be covered.
- The pipework must be flushed out to remove any debris which can affect the function of this product.
- A corrosion inhibitor should be used in your installation.

BTU & Wattage info-

Product Code	BTU	Wattage
SAVMB1695	1170	343

# Parts

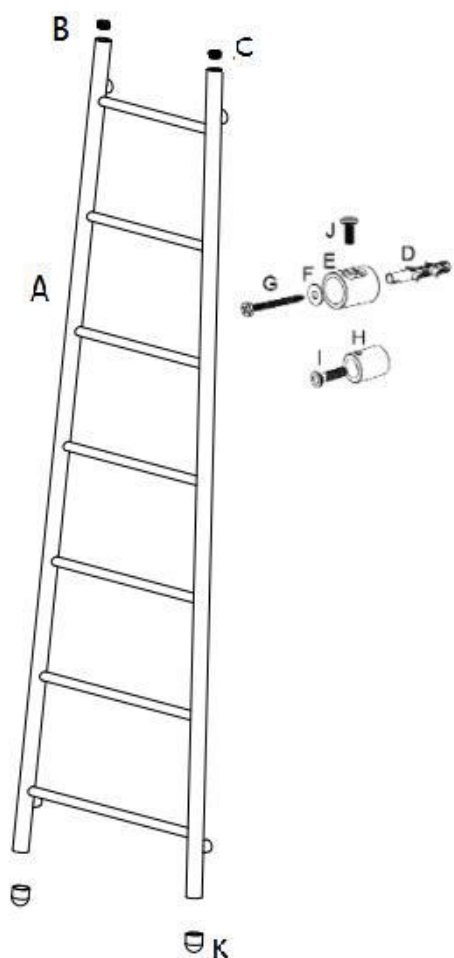

- A. 1 x Radiator
- B. 1 x Air Vent (Bleed Valve)
- C. 1 x Blanking Cap
- D. 4 x Wall plug
- E. 4 x Wall Bracket
- F. 4 x Washer
- G. 4 x Wall screw
- H. 4 x Rail Bracket
- I. 4 x Bracket Screw
- J. 4 x Connecting Screw
- K. 2 x Cover

Please note that Parts are for illustrative purposes only and may differ slightly to the actual product

## Tools required

- Spanner
- Flathead screwdriver
- Philips screwdriver
- Tape measure
- Drill and 8mm drill bit
- Spirit Level
- Pencil
- Sealing tape

# Installation

**Please note:** Before starting any installation, turn off the water supply.

**Please note:** Before commencing any installation, the desired location should be checked before drilling, that no pipes or wires can be damaged.

First, prepare the water supply pipes to match up with the towel radiator and valve dimensions being used. Fit the radiator valve tail and nut into the towel rail (not supplied) (at both sides) and using sealing tape, tighten into position, then follow the installation below.

1. Fit the blanking cap, air vent and covers in the towel rail, (add a little sealer tape to secure) and tighten using the spanner, be sure not to overtighten.



2. The rear of the towel rail has four location holes to fix the brackets. Measure the distance between all the location holes and mark these on the wall in the required location, use a spirit level to ensure these are horizontally and vertically aligned.

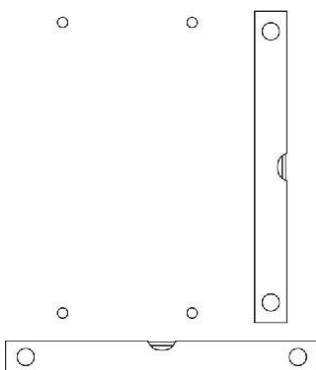

- Using the drill and 8mm drill bit, drill into the marked positions then insert the wall plugs and tap flush to the finished wall surface.

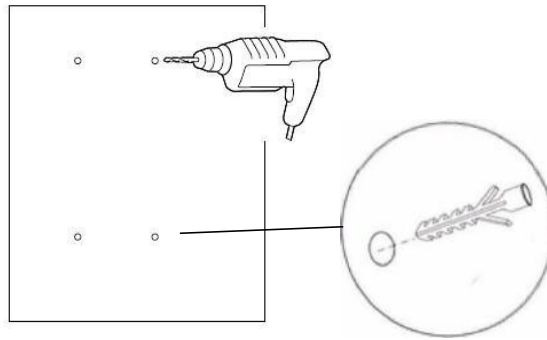

**Please note:** If drilling into a tile, it is recommended to tape the wall to prevent the drill from slipping.

- Position the wall brackets and screw into place using the screws provided (securing each with a washer) with the Philips screwdriver.

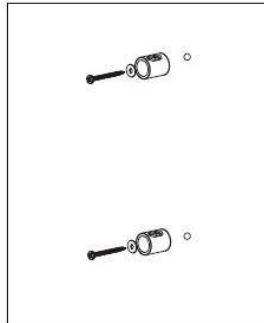

- Next, proceed to fix the rail brackets to the rear of the radiator and screw into place using the screws provided with the Philips screwdriver.

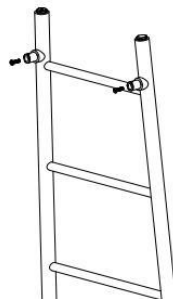

- Align and push the rail brackets on the radiator onto the wall brackets secured to the wall. Secure the two together with the connecting screws provided (insert through the slot in the bracket) and tighten using the Philips screwdriver, be sure not to overtighten.

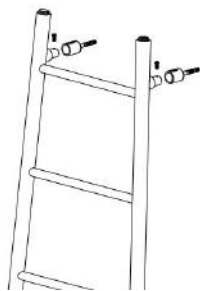

**Please note:** You may need two people to connect the radiator, depending on the model purchased.

- Finally, fit the radiator valves to the pipework and connect to the radiator valve tail and tighten all connections.

**IMPORTANT!** The product is supplied un-filled.

The rail should be filled with a water (80%) and glycol (20%) mixture if **NOT** being connected to the central heating system, also allow 5% air gap.

## After installation

- After the above installation, turn on the water supply and using the flathead screwdriver, open the air vent via the central screw, open the inlet valve and let the water rush into the radiator. Check all connections for leaks.
- Once water overflows from the air vent, this means that there will be no air bubbles present.
- Use a screwdriver to close the air vent and then the radiator is ready to use.

## Cleaning

This radiator is made from steel with a painted finish. To maintain the surface of your product (especially when subjected to steam or splashes), wipe with a clean damp cloth and wipe dry.

Do not use abrasive cleaning agents or materials which can strip and scratch the surface; the use of these agents or materials can invalidate your guarantee.

It is recommended to wipe and dry on a regular basis.

### **For more information**

- visit [betterbathrooms.com](http://betterbathrooms.com)
- email [customerservices@buyitdirect.co.uk](mailto:customerservices@buyitdirect.co.uk)
- call 0330 390 3062
- write to Trident Business Park, Neptune Way, Huddersfield, HD2 1UA

**better  
bathrooms**

Part of the BuyItDirect Group